

QUICK START GUIDE

# Server Specialty Dispenser with Eco Pump™

Tips and tricks to help you get started with your new dispenser with Eco Pump™.

**1** Remove pump from box and disassemble then wash, rinse, and sanitize all pump parts properly before use.



**2** Install seal onto head assembly piston. Apply small amount of food equipment lubricant inside seal. Flared end of seal should face away from piston head. Install pinch valve securely to seal end. Squeeze pinch valve open before installation.

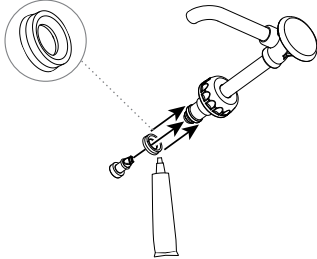

**3** Insert spring into cylinder. Add silicone tube to bottom of cylinder.

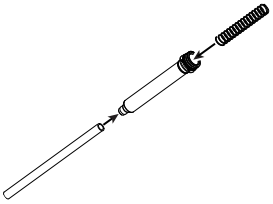

**4** Snap cap onto cylinder. Press firmly to secure cap down over all threading on cylinder

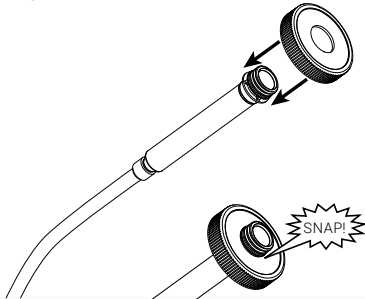

**5** Install head assembly in cylinder. Apply small amount of food equipment lubricant to the outside of seal. Slide locking collar down onto cylinder threading. Tighten firmly.

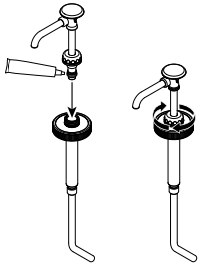

**6** Insert and secure pump to jug of product. Tighten cap very firmly onto jug threading. Place jug into shroud.



**7** Add lid.

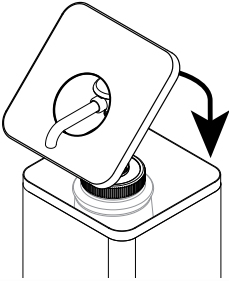

**8** Prime pump by continuously pressing on the pump until any air bubbles are eliminated and only product is dispensed.

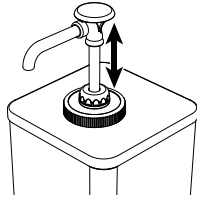

**9** This pump can also be cleaned-in-place without disassembly. For complete instructions for cleaning-in-place, scan the QR code below and look up your part number in the search bar to find the manual.

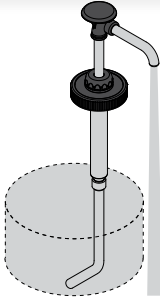

**WANT TO LEARN MORE?**

Visit [server-products.com/manual-more](http://server-products.com/manual-more) for your manual, part breakdown, support videos and more.  
[spsales@server-products.com](mailto:spsales@server-products.com) | 800.558.8722

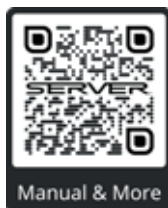

MODEL  
XXXX  
P/N  
#####

NSF®

SERIES  
##X ##X

**2** YEAR  
WARRANTY

REFERENCE YOUR PART NUMBER (P/N) LOCATED ON THE LID OR BASE.