



QUICK START GUIDE

Server ConserveWell®

Tips and tricks to help you get started with your new ConserveWell®.

1 Remove unit from box. Wash pan and pan liner properly before use.

 Never immerse complete unit into water. Electrical shock could occur.

 Only use with utensils safe in high temperatures. Do not use with liquid or gel-filled utensils. Handles become extremely hot.



2 Select countertop hole for unit to drop into. Consider best placement for ease of use. 15.24 cm (6") of clearance needed below countertop. Ensure cord can reach power source. Unit fits within existing countertop hole cutout diameters 13.97 - 16.5 cm (5.5" - 6.5"). Unit is factory assembled to fit 15.24 cm diameter holes. For a new hole, use appropriate personnel and tools to cut a 15.24 cm diameter hole.



3 OPTIONAL - Add anti-rotational foot to prevent unit pivoting within countertop hole. Remove outer screw from cord guard. Insert anti-rotational foot in place of removed screw. Drill foot hole in countertop. Refer to cutout template in manual for template and dimensions.

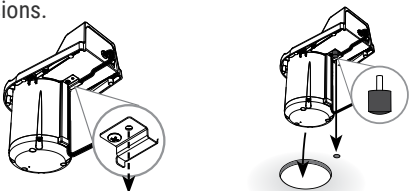

4 Select location block hardware to create proper fit within countertop hole. Hole diameter determines which 3 location blocks to use. If size is between two listed dimensions, refer to the smaller diameter.

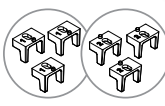

COUNTERTOP HOLE DIAMETER	LOCATION BLOCKS
13.97 cm.....	No location blocks needed
14.6 cm.....	BLUE, embossed with "1"
15.24 cm.....	BLUE, embossed with "1"
15.87 cm.....	RED, embossed with "2"
16.5 cm.....	RED, embossed with "2"

5 Attach 3 location blocks into slots in underside of rim. Slide location blocks either away from or towards base. Refer to chart.

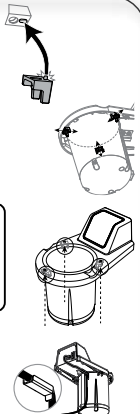

COUNTERTOP HOLE DIAMETER	LOCATION BLOCK FITTING
13.97 cm.....	Remove all location blocks
14.6 cm.....	BLUE, slide towards base
15.24 cm.....	BLUE, slide away from base
15.87 cm.....	RED, slide towards base
16.5 cm.....	RED, slide away from base

Insert unit and cord into countertop hole. Use cord guard only if cord is plugged in under counter.

6 Insert green pan liner into bottom of pan. Fill 28 oz. of hot water up to fill-line of pan. Insert pan of water into basin. Pour water into pan only, never directly into basin. Plug cord into power source. Press switch on back of unit to turn unit on. Press RESET to start countdown timer.

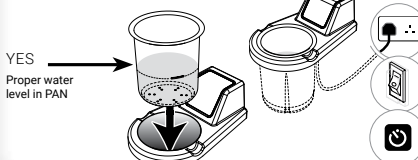

YES → Proper water level in PAN

7 To change out water, remove and empty pan of water into a drain. Keep the pan liner inside pan. Refill pan with water and return to basin.

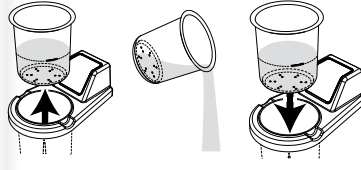

 **CAUTION- HOT**
Unit, pans and water will be hot.

8 Be aware of the water temperature. Help prevent bacteria growth. The FDA warns that bacteria grows most rapidly in the range of temperatures between 5°C - 57°C (41°F - 135°F).

WATER HEATING TIMES (When unit is not pre-heated)				
INITIAL WATER TEMP.	TARGET TEMPERATURE			
	57°C	60°C	62°C	
21°C	40 min.	45 min.	50 min.	
43°C	25 min.	30 min.	40 min.	
49°C	20 min.	20 min.	30 min.	
54°C	15 min.	20 min.	25 min.	

WATER HEATING TIMES (In pre-heated unit)				
INITIAL WATER TEMP.	TARGET TEMPERATURE			
	57°C	60°C	62°C	
21°C	30 min.	35 min.	40 min.	
43°C	15 min.	20 min.	25 min.	
49°C	5 min.	10 min.	15 min.	
54°C	5 min.	5 min.	10 min.	

9 For units that have a countdown timer, press RESET to start the countdown cycle. Timer is factory preset for 4 hour cycles. When timer ends, an alarm will beep and the display will indicate "END". Press RESET to stop alarm, change out the water and press RESET to restart timer. See manual for instructions for reprogramming timer.

WANT TO LEARN MORE?

Visit server-products.com/manual-more for your manual, part breakdown, support videos and more.
spsales@server-products.com | 800.558.8722

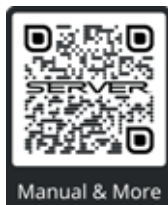

MODEL XXXX P/N #####

NSF

SERIES ##X ##X

2 YEAR WARRANTY

REFERENCE YOUR PART NUMBER (P/N) LOCATED ON THE LID OR BASE.