



SERVER

120 Volt
4 Quart Vessel
Heating Element
Replacement Kit

Stock No. 81051

Kit includes heating element
#81008 for All Series of:

- BS Units
- FS Units
- Twin FS Units
- FS-4 Units
- NC Units
- HS Units and HSS-3 Units

OLD HEATING ELEMENT REMOVAL

- TURN UNIT OFF AND UNPLUG CORD.
Allow unit to fully cool if unit has been in operation.
- EMPTY ANY CONTENTS AND/OR WATER FROM VESSEL(S).
Remove all accessories from unit.
- REMOVE THERMOSTAT KNOB(S).
 - Knob Guard(s) must be removed, if included with unit. Remove 2 screws located at bottom of knob guard.
 - Knob(s) which are pointer style in shape, if included with unit, have a setscrew that must be removed in order to remove knob.
- DISASSEMBLE WATER VESSEL(S) FROM SHROUD ENOUGH TO ACCESS WIRING.
 - Place unit on side to remove screws securing shroud or bottom closer to water vessel.
 - Units may have rubber feet which need to be removed first.
 - Older units may have 4 screws around top rim of shroud which can be removed to release shroud.
 - Slowly pull vessel away from shroud by tilting shroud until thermostat shaft clears hole provided in shroud.
- CUT WIRE TIES AND DISCONNECT GREEN GROUND LEAD IF NECESSARY TO FURTHER ACCESS INTERNAL WIRING.
 - Units with lights and/or a spout warmer may require more lead disconnections to further access internal wiring.
- DISCONNECT CORD ASSEMBLY WHITE LEAD FROM HEATING ELEMENT LEAD (A).
- DISCONNECT THERMAL CUTOUT LEAD FROM THERMOSTAT.
Heating element can be best accessed when vessel is set upside down on a work surface.
- DISCONNECT HEATING ELEMENT LEAD (B) FROM THERMOSTAT.
- MARK LOCATIONS OF OLD HEATING ELEMENT AND THERMOSTAT BRACKET ON WATER VESSEL FOR ACCURATE REPLACEMENT OF NEW HEATING ELEMENT. SEE ILLUSTRATION FOR RECOMMENDED MARKING LOCATIONS.
- REMOVE OLD HEATING ELEMENT AND THERMOSTAT BRACKET FROM WATER VESSEL BY REMOVING BOLT LOCATED AT GAP WHERE TWO ENDS OF HEATING ELEMENT MEET OVER THERMOSTAT BRACKET.
 - Discard old heating element, but save thermostat bracket with thermostat mounted to it.
 - Older units may have one or two bolts with nuts located at gap where two ends of heating element meet over thermostat bracket.
 - Older units may require use of tin snips to cut apart retaining strap securing old heating element to water vessel. Also remove and discard the two nuts and lockwashers which secured old heating element to bottom of water vessel.
 - **CAUTION:** If cutting old retaining strap, strap may expand rapidly and cause bodily harm.

NEW HEATING ELEMENT INSTALLATION

- SET WATER VESSEL UPSIDE DOWN ON WORK SURFACE.
- INSTALL NEW HEATING ELEMENT AND THERMOSTAT BRACKET, WITH THERMOSTAT MOUNTED TO IT, ONTO BASE OF WATER VESSEL.
 - Align these parts according to marking made previously during old heating element removal procedure.
 - Place heating element onto base of water vessel with lead wires pointing towards bottom of water vessel.
 - Position heating element to wrap evenly around base of water vessel, just below radius on bottom edge of water vessel. This will allow heating element to be in consistent contact with circumference of water vessel for optimum unit operation.
 - Position thermostat bracket, with thermostat mounted to it, between water vessel and heating element. Center thermostat bracket behind gap between two ends of heating element.
- SECURE HEATING ELEMENT AND THERMOSTAT BRACKET TO WATER VESSEL.
 - Tighten bolt between gap of two ends of heating element.
- BEGIN CONNECTING LEADS AND INSTALLING WATER VESSEL INTO SHROUD.
- CONNECT HEATING ELEMENT LEAD (B) TO THERMOSTAT.
Either thermostat terminal is acceptable.
 - Older units may have a thermostat with a ring terminal.
This requires utilization of provided extension lead wire to connect heating element lead (B) to thermostat.
- CONNECT THERMAL CUTOUT LEAD TO THERMOSTAT.
Either thermostat terminal is acceptable.
- OPPOSITE END OF THERMAL CUTOUT LEAD SHOULD BE CONNECTED TO BLACK LEAD FROM ROCKER SWITCH.
 - If unit has lights and/or a spout warmer, the above connection should also include one of the two spout warmer leads and the two black leads from lights.
- CONNECT GREEN GROUND LEAD WITH NUT TO THREADED STUD INSIDE SHROUD.
- CONNECT HEATING ELEMENT LEAD (A) WITH WIRE NUT TO CORD ASSEMBLY WHITE LEAD.
 - If unit has lights and/or a spout warmer, the above connection should also include one of the two spout warmer leads and the two white leads from lights.
- GATHER AND SECURE ALL WIRE WITH WIRE TIES.
 - Bundle wires to prevent them from touching heating element.
- INSTALL WATER VESSEL BACK INTO SHROUD.
 - Tilt water vessel while slowly sliding and aligning it into shroud.
 - Align thermostat shaft into hole provided in shroud.
- SECURE WATER VESSEL TO SHROUD.
 - Rubber feet may need to be installed to secure bottom closer to shroud.
 - Older units may have 4 screws around top rim of shroud which need to be installed to secure water vessel to shroud.
- INSTALL THERMOSTAT KNOB ONTO THERMOSTAT SHAFT BY ALIGNING KNOB ONTO SPLINE ON SHAFT AND PUSHING KNOB ONTO SHAFT.
 - Knobs which are pointer style in shape, if included with unit, have a setscrew which must be installed to secure knob to unit.
 - Knob Guard must be installed, if included with unit.
Install 2 screws located at bottom of knob guard.

Kit Includes:

| Part No. | Qty. | Description |
|----------|------|-------------------------|
| 81008 | 1 | HEATING ELEMENT |
| 81053 | 1 | 3" BLACK EXTENSION WIRE |

Heating Element

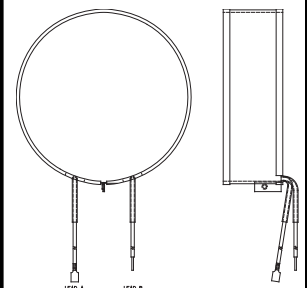

3" Extension Wire

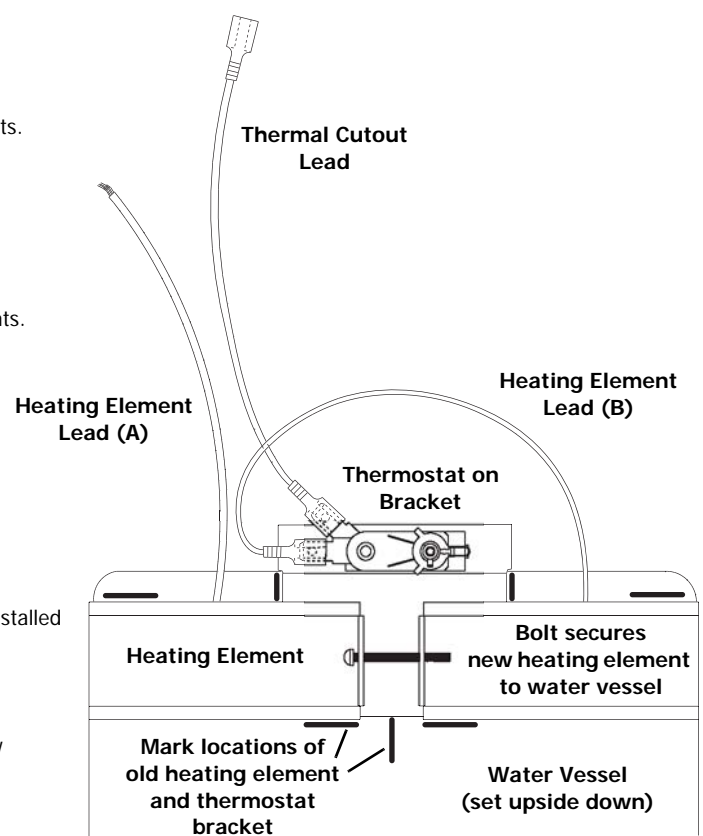

FS, FSP (SERIES 89A, 89J, 93D, 96G)
FSP LOW TEMP (SERIES 98H)
FS-4 (SERIES 89A, 89J)

120V/60Hz

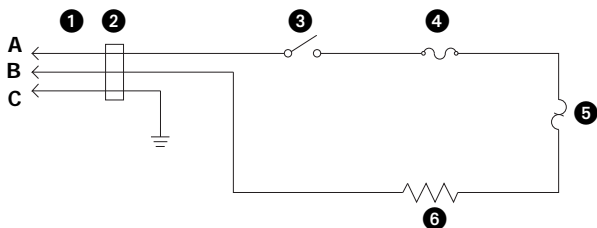

FS, FSP, FS-4, BS (SERIES 02E)

120V/60Hz

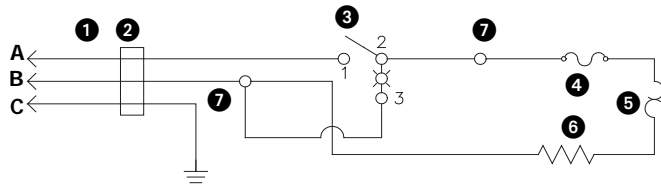

FSPW (SERIES 97F, 97J)
FSPWI (SERIES 88, 89A, 89K, 93D, 96G)
FSPWI (96H, 97F, 97J)

120V/60Hz

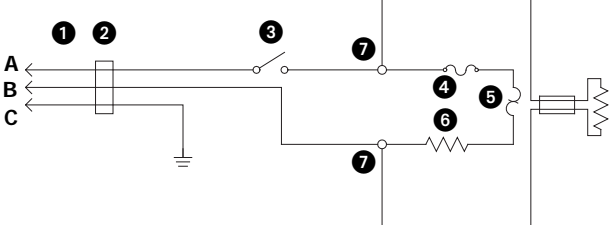

FSPW, FSPWI, BSW, BSWI (SERIES 02E)

120V/60Hz

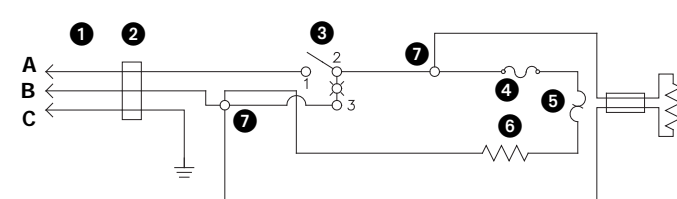

LFS, LFSP (88, 89A, 89K, 93D)
LBS (SERIES 89A, 89K, 93I, 96G)
LFS-4, LNCS (SERIES 88, 89A, 89K)

120V/60Hz

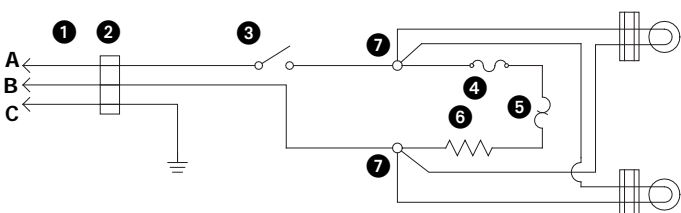

LFS, LFSP, LBS, LFS-4, LNCS (SERIES 97F)

120V/60Hz

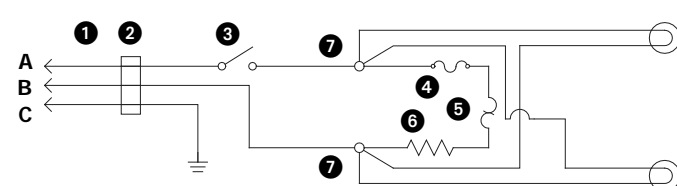

LFSPW, LFSPWI, LNCSW, LNCSWI (SERIES 88, 89A, 89K, 93D, 96G)
LBSW, LBSWI (SERIES 89A, 89K, 93I, 96G)
LHSSW, LHSSWI (SERIES 88, 89A, 89K, 93D)

120V/60Hz

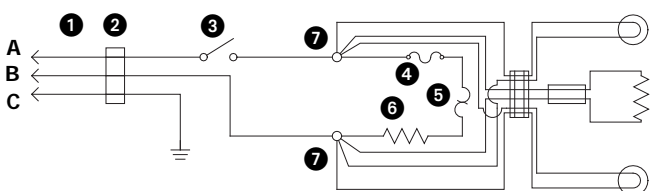

120V/60Hz

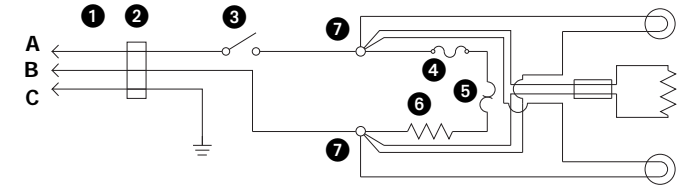

TWIN FS, TWIN FSP (SERIES 84, 89A, 89K, 90J, 93D)
TWIN FS-4 (SERIES 96H, 97F, 97J)

120V/60Hz

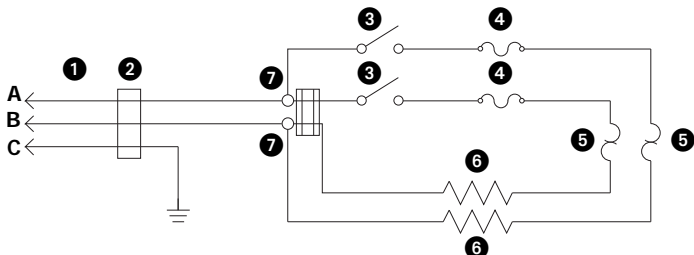

HSS-3 (SERIES 89A, 93D, 97F)

120V/60Hz

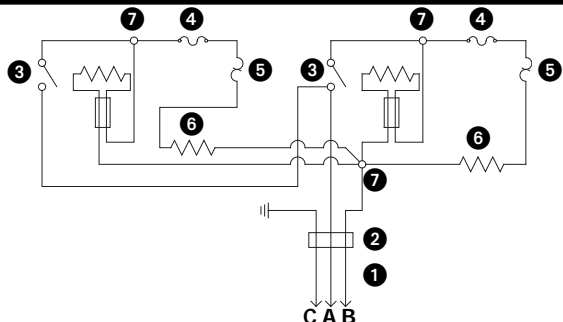

WIRING DIAGRAMS

1 Cord Assembly

120V/60Hz

A Black
B White
C Green (Ground Wire)

2 Bushing and/or Strain Relief

3 Snap-In Rocker Switch

4 Thermal Cut-Out

5 Thermostat

6 Heating Element

7 Wire Nut



SERVER



Server Products Inc.
3601 Pleasant Hill Road
Richfield, WI 53076 USA



(262) 628-5600



(800) 558-8722



(262) 628-5110



spsales@server-products.com



www.server-products.com