

Decrease waste. Increase wow.

EZ-Topper™ Pouched Topping Warmers



Dispense more servings with eco-friendly pouched topping dispensers; deliver up to 98% evacuation

Minimize downtime during changeouts – models simultaneously warm a reserve pouch

Promote dessert consistency with portion control; stainless steel pump dispenses 30 mL max adjustable in 3.7 mL increments



Pouch with fitment creates sealed, sanitary system without the mess



Twin w/ Spout Heater
Euro – 84981
Aust – 84982
UK – 84983



Single w/ Spout Heater
Euro – 84987
Aust – 84988
UK – 84989



Single w/o Spout Heater
Euro – 84994
Aust – 84995
UK – 84996



EZ-Topper™ Pouched Topping Warmers
Model EZT & EZT-S 230V

FAST FACTS

- Serve fudge or caramel from 1.4 L pouches* with 16 mm center fitment, available through your food distributor
- Pouches create 97% less packaging waste than cans
- Warms without a water bath

APPLICATIONS

- Tamper-resistant packaging is ideal for self-serve dessert stations
- High-volume operations looking to minimize downtime during changeouts
- Lower-volume or sporadic use operations serving toppings over an extended period of time

More servings. More responsible. Sweet.

EZ-Topper™ Pouched Topping Warmers

Model EZT & EZT-S 230V





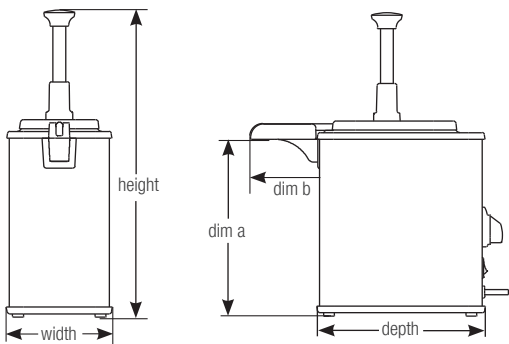



SPECIFIER STATEMENT

84981 | 84982 | 84983 | 84897 | 84988 | 84989 | 84994 | 84995 | 84996: Server Products Model EZT and EZT-S EZ-Topper™ pouched topping warmers accept specialized 1.4 L topping pouches* with 16 mm center fitment and warm with dry heat (no water bath). Twin warmers use individual temperature sensing thermostats to control wrap-around heating elements for each well. Temperatures range from 38°C to 93°C. Stainless steel pumps dispense 30 mL max adjustable in 3.7 mL increments. Stainless steel pouch support included for operation without heating reserve pouch. Includes caramel and hot fudge magnetic merchandising graphics. Black, engraved knobs included to indicate caramel and/or fudge inside as well as blank, black knob on each pump. NSF Listed. CE and RCM approved. Two-year warranty. Ships FOB Richfield, WI 53076.



Adjustable thermostat heats and holds temperature as topping depletes to avoid scorching



order qty	model/item	plug type	description	holds/capacity	dims (H x W x D)	dim a	dim b	weight
<input type="checkbox"/>	EZT 84981		Twin base warms spouts and (4) pouches	(4) 1.4 L pouches; (2) active (2) reserve	44.1 x 30.2 x 24.4 cm	26.1 cm	9.8 cm	11.3 kg
<input type="checkbox"/>	EZT 84982							
<input type="checkbox"/>	EZT 84983							
					Electrical	230V	400W	1.7A
<input type="checkbox"/>	EZT-S 84987		Single base warms spout and (2) pouches	(2) 1.4 L pouches; (1) active (1) reserve	44.1 x 15.2 x 24.4 cm	26.1 cm	9.8 cm	6.6 kg
<input type="checkbox"/>	EZT-S 84988							
<input type="checkbox"/>	EZT-S 84989							
					Electrical	230V	200W	.9A
<input type="checkbox"/>	EZT-S 84994		Single base warms (2) pouches	(2) 1.4 L pouches; (1) active (1) reserve	44.1 x 15.2 x 24.4 cm	26.1 cm	9.8 cm	6.4 kg
<input type="checkbox"/>	EZT-S 84995							
<input type="checkbox"/>	EZT-S 84996							
					Electrical	230V	200W	.9A

*Contact your food distributor for special 1.4 L topping pouches with a 16 mm center fitment; currently packaged by: Ghirardelli Chocolate Company, The Hershey Company, Lyons Magnus, and Masterson Company.