

Organize with ease.

Express™ Pouched Dispensers



Perfect for high-traffic, self-serve stations;
fit up to 6 flavors in a small footprint

Manage food costs and flavor
with precise portion-control

Branding-ready – incorporate
your brand and flavors for quick
product identification

Countertop and drop-in models are
available to suit operational needs

Sealed, sanitary system achieves
up to 98% product evacuation

STAINLESS STEEL SINGLES

(details on p 2)



SE-SS 07125



SE-SS 07020

BLACK PLASTIC SINGLES

(details on p 3)



SE 07000



SE 07010



SS-1SE 67760



SS-2SE 07300

STAINLESS STEEL STATIONS

(details on p 4)



SE-2 07140



SE-2DI 07160



SE-3 07040



SE-3DI 07050



SE-4 07200



SE-4DI 07210



SE-5 07060



SE-5DI 07070

STAINLESS STEEL SLIM STATIONS

(details on p 4)



SLE-2 07520



SLE-3 07530



SLE-6 07540

FAST FACTS







- 1 oz maximum portion; adjusts in 1/4 oz increments
- ADA Compliant lever dispenses with less than five pounds of pressure

APPLICATIONS

- Serve ketchup, mustard, mayo, tartar sauce and more at customer self-serve stations
- Models for countertop or drop-in applications

Taste-boosting, waste-reducing.

Stainless Steel Express™ Single Dispensers Models SE-SS

DISPENSES	 THIN fountain syrups • oils • hot sauce
	 THICK ketchup • mustard • mayonnaise • bbq
	 THICKER tartar sauce • crafted sauces
APP	 AMBIENT
	 COLD
	 HOT

SPECIFIER STATEMENT





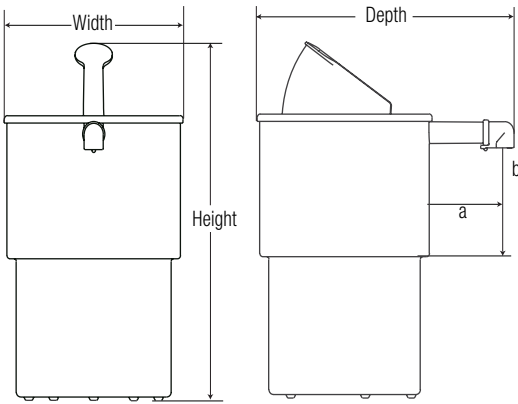





07125 | 07020: Server Products Stainless Steel Express™ single dispenser is constructed of a stainless steel vessel with a brushed finish, surgical-quality plastic pump and stainless steel lid. Unit dispenses thin, thick, or thicker toppings from a 1 ½ gal (6 L) pouch with a 16 mm fitment. Maximum 1 oz (30 mL) portion can reduce in ¼ oz (7 mL) increments using adjustable lever. NSF listed, BPA Free and ADA Compliant. Two-year warranty. Ships FOB Richfield, WI 53076.

  **ADA** compliant | Less than 5 lbs of pressure to dispense.



model/item	drop-in cutout (W x D)
SS-SE 07020	6 3/8" x 8 1/2" 16.2 x 21.6 cm

Pump connects to a 1.5 gal (6 L) Cryovac pouch with 16 mm fitment

order quantity	dispenses	model/item	application	description	capacity	dims (H x W x D)	weight	dim a	dim b
	  	SS-SE 07020		Stainless steel, drop-in	1.5 gal 6L	10 7/16" x 6 3/8" x 13 5/8" 26.5 x 16.2 x 34.6 cm	9 lb	4 1/4" 10.8 cm	5 1/2" 14 cm
	  	SS-SE 07125		Stainless steel, countertop		17 9/16" x 6 3/8" x 13 3/16" 26.5 x 16.2 x 33.5 cm	4.1 kg	4 1/4" 10.8 cm	12 1/2" 31.8 cm

Organize with ease.

Black Plastic Express™ Single Dispensers Models SE, SS-1SE & SS-2SE

SPECIFIER STATEMENT





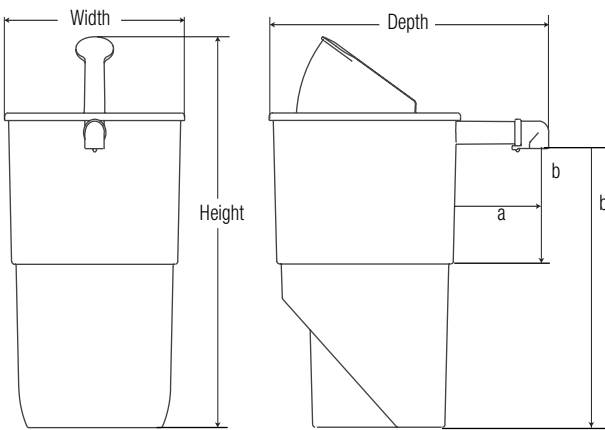















07000 | 07010 | 67760 | 07300: Server Products Express™ single dispenser is constructed of a black thermoset polyester vessel, surgical-quality plastic pump and stainless steel lid. Unit dispenses thin, thick, or thicker toppings from a 1 ½ gal (6 L) pouch with a 16 mm fitment. Maximum 1 oz (30 mL) portion can reduce in ¼ oz (7 mL) increments using adjustable lever. NSF listed, BPA Free and ADA Compliant. Two-year warranty. Ships FOB Richfield, WI 53076.

   Less than 5 lbs of pressure to dispense.





model/item	drop-in cutout (W x D)
SE 07010	8 ½" diameter 21.6 cm diameter
SE 07000	6 ¾" x 8 ½" 16.2 x 21.6 cm





order quantity	dispenses	model/item	application	description	capacity	dims (H x W x D)	weight	dim a	dim b
	  	SE 07010		Round, black plastic countertop or drop-in	1.5 gal 6L	17 7/16" x 9 5/8" x 14" 44.3 x 24.4 x 35.6 cm	8 lb	4 5/16"	5 1/8"
	  	SE 07000		Rectangular, black plastic countertop or drop-in		17 5/8" x 7 1/2" x 14" 44.8 x 19.1 x 35.6 cm	3.6 kg	11 cm	13 cm
	  	SS-1SE 67760		07000 with st st base, countertop		17 3/4" x 7 1/2" x 14" 45.1 x 19.1 x 35.6 cm	10 lb 4.5 kg	4 1/2"	12 3/4"
	  	SS-2SE 07300		(2) 07000 with st st base, countertop		17 3/4" x 14 15/16" x 14" 45.1 x 37.9 x 35.6 cm	17 lb 7.7 kg	11.4 cm	32.4 cm

DISPENSES

-  **THIN**
fountain syrups • oils • hot sauce
-  **THICK**
ketchup • mustard • mayonnaise • bbq
-  **THICKER**
tartar sauce • crafted sauces

APP

-  **AMBIENT**
-  **COLD**
-  **HOT**

Taste-boosting, waste-reducing.

Stainless Steel Express™ Stations

Models SE-2, SE-2DI, SE-3, SE-3DI, SE-4, SE-4DI, SE-5, SE-5DI, SLE-2, SLE-3 & SLE-6, SLE-6DI

SPECIFIER STATEMENT

DISPENSES

- THIN
fountain syrups • oils • hot sauce
- THICK
ketchup • mustard • mayonnaise • bbq
- THICKER
tartar sauce • crafted sauces

APP

- AMBIENT
- COLD
- HOT

07140 | 07160 | 07040 | 07050 | 07200 | 07210 | 07060 | 07070 | 07080 | 07520 | 07530 | 07540 | 07550: Server Products Stainless Steel

Express™ stations and slim stations are constructed of a stainless steel vessel with a brushed finish, surgical-quality plastic pumps and stainless steel lids. Stations dispense thin, thick, or thicker toppings from 1 ½ gal (6 L) pouches with 16 mm fitments, and slim stations accept 3 qt (2.8 L) pouches with 16 mm fitments. Maximum 1 oz (30 mL) portion can reduce in ¼ oz (7 mL) increments using adjustable lever. NSF listed, BPA Free and ADA Compliant. Two-year warranty. Ships FOB Richfield, WI 53076.

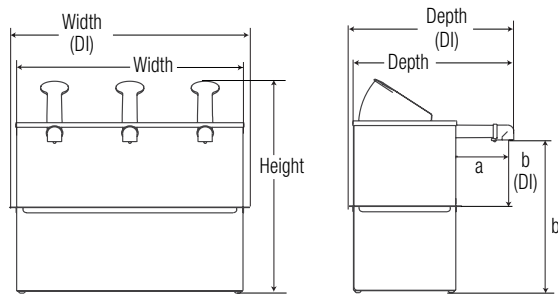

model/item	drop-in cutout (W x D)
SE-2DI 07160	11" x 8 ½" 27.9 x 21.6 cm
SE-3DI 07050	16 ¾" x 8 ½" 41.6 x 21.6 cm
SE-4DI 07210	21 13/16" x 8 ½" 55.4 x 21.6 cm
SE-5DI 07070	27 3/16" x 8 ½" 69.1 x 21.6 cm
SLE-6DI 07550	21 13/16" x 8 ½" 52.9 x 21.6 cm

STATIONS

order quantity	dispenses	model/item	application	description	capacity	dims (H x W x D)	weight	dim a	dim b
□	THIN, THICK, THICKER	SE-2 07140	AMBIENT	(2) 07794 pumps, countertop	(2) 1.5 gal	17 ½" x 11" x 13 5/16" 44.5 x 27.9 x 33.8 cm	15 lb	4 1/4"	12 9/16"
□	THIN, THICK, THICKER	SE-2DI 07160	AMBIENT	(2) 07794 pumps, drop-in (DI)	(2) 6L	10 7/16" x 11 7/8" x 13 3/4" 26.5 x 30.2 x 34.9 cm	6.8 kg	4 1/4"	5 7/16"
□	THIN, THICK, THICKER	SE-3 07040	AMBIENT	(3) 07794 pumps, countertop	(3) 1.5 gal	17 ½" x 16 3/8" x 13 5/16" 44.5 x 41.6 x 33.8 cm	18 lb	4 1/4"	12 9/16"
□	THIN, THICK, THICKER	SE-3DI 07050	AMBIENT	(3) 07794 pumps, drop-in (DI)	(3) 6L	10 7/16" x 17 1/4" x 13 3/4" 26.5 x 43.8 x 34.9 cm	8.2 kg	4 1/4"	5 7/16"
□	THIN, THICK, THICKER	SE-4 07200	AMBIENT	(4) 07794 pumps, countertop	(4) 1.5 gal	17 ½" x 21 13/16" x 13 5/16" 44.5 x 55.4 x 33.8 cm	22 lb	4 1/4"	12 9/16"
□	THIN, THICK, THICKER	SE-4DI 07210	AMBIENT	(4) 07794 pumps, drop-in (DI)	(4) 6L	10 7/16" x 22 11/16" x 13 3/4" 26.5 x 55.6 x 34.9 cm	10 kg	4 1/4"	5 7/16"
□	THIN, THICK, THICKER	SE-5 07060	AMBIENT	(5) 07794 pumps, countertop	(5) 1.5 gal	17 ½" x 27 3/16" x 13 5/16" 44.5 x 69.1 x 33.8 cm	34 lb	4 1/4"	12 9/16"
□	THIN, THICK, THICKER	SE-5DI 07070	AMBIENT	(5) 07794 pumps, drop-in (DI)	(5) 6L	10 7/16" x 28 1/16" x 13 3/4" 26.5 x 71.3 x 34.9 cm	15.4 kg	4 1/4"	5 7/16"
□	THIN, THICK, THICKER	SE-6 07080	AMBIENT	(6) 07794 pumps, countertop	(6) 1.5 gal	17 9/16" x 32 5/8" x 13 3/16" 44.6 x 82.9 x 33.5 cm	35 lb	4 1/4"	12 9/16"
					(6) 6L		15.9 kg	10.8 cm	31.9 cm

SLIM STATIONS

order quantity	dispenses	model/item	application	description	capacity	dims (H x W x D)	weight	dim a	dim b
□	THIN, THICK, THICKER	SLE-2 07520	AMBIENT	(2) 07794 pumps, slim base	(2) 96 oz	17 9/16" x 7 7/16" x 13" 44.6 x 18.9 x 33 cm	10 lb	4 1/4"	12 5/16"
□	THIN, THICK, THICKER	SLE-3 07530	AMBIENT	(3) 07794 pumps, slim base	(3) 96 oz	17 9/16" x 11" x 13" 44.6 x 27.9 x 33 cm	13 lb	4 1/4"	12 5/16"
□	THIN, THICK, THICKER	SLE-6 07540	AMBIENT	(6) 07794 pumps, slim base	(6) 96 oz	17 9/16" x 21 13/16" x 13" 44.6 x 55.4 x 33 cm	24 lb	4 1/4"	12 5/16"
□	THIN, THICK, THICKER	SLE-6DI 07550	AMBIENT	(6) 07794 pumps, slim drop-in (DI)	(6) 96 oz	10 7/16" x 22 11/16" x 13 5/8" 26.5 x 57.6 x 34.6 cm	24 lb	4 1/4"	5 7/16"
							10.9 kg	10.8 cm	13.8 cm